



Swedstyle Memory

Operating manual

CONTENT

1	General information.....	4
2.	Safety.....	4
2.1	General safety regulations.....	4
2.2	Intended use.....	4
2.3	Reasonably foreseeable misuse.....	4
2.4	Liability.....	5
2.5	Residual risks.....	5
3	The product.....	6
3.1	Key product features.....	6
3.2	Dimensions.....	7
4	Assembly.....	7
4.1	Required components.....	8
4.2	Process.....	8
4.3	Completing assembly.....	8
5	Operation.....	8
5.1	Adjusting the table top height.....	9
5.2	Saving a memory position.....	10
6	Additional information.....	10
6.1	Disassembly.....	10
6.2	Maintenance.....	10
6.3	Cleaning.....	11
6.4	Replacing a handset.....	11
6.5	Troubleshooting.....	11
6.6	Disposal.....	11

1 GENERAL INFORMATION

Assembly personnel must read all documentation before starting assembly. Keep all documentation for as long as the product is in your possession. Ensure that all documentation is provided to subsequent owners. This Manual may change without notice. The most recent version is available on our website.

2 SAFETY

Handsets may only be installed by Skilled Persons. A Skilled Person is defined as someone who:

- Is authorized for installation planning, installation, commissioning, or servicing of the product
- Has read and understood all documentation relevant to the Handset
- Has the technical education, training, and/or experience to perceive risks and avoid hazards
- Has knowledge of the specialist standards applicable to the product
- Has the expertise to test, assess, and manage electrical and mechatronic products and systems in accordance with the generally accepted standards and guidelines of electrical engineering and furniture manufacturing

2.1 General safety regulations

In general, the following safety regulations and obligations apply when handling the product:

- Do not operate the product unless it is in a clean and perfect condition
- Do not remove, change, bridge, or bypass any protection, safety, or monitoring equipment
- Do not convert or modify any components
- In the event of malfunction or damage, faulty components must be replaced immediately
- Unauthorized repairs are prohibited
- Do not attempt to replace hardware unless the product is in a de-energized state
- Only Skilled Persons are allowed to work with "Memory" hand controller
- Ensure that national worker protection conditions and national safety and accident prevention regulations are observed during operation of the system

2.2 Intended use

This product is a Handsets for electrically Height-Adjustable Tables. It is used to control Height-Adjustable Table systems via a Control Box. It is intended for indoor use only. It may only be installed in compatible Height-Adjustable Tables and with Swedstyle-approved accessories. Use beyond or outside the intended use will void the product's warranty.

2.3 Reasonably foreseeable misuse

Usage outside of the intended use may lead to minor injury, serious injury, or even death. Reasonably foreseeable misuse of the Handset includes, but does not extend to:

- Connecting unauthorized parts to the product. If you are unsure as to whether a part can be used with a Handset, contact Swedstyle for further information

2.4 Liability

Swedstyle products comply with all currently applicable health and safety regulations. However, risk can result from incorrect operation or misuse. Swedstyle is not liable for damage or injury caused by:

- Improper product use
- Disregard of the documentation
- Unauthorized product alterations
- Improper work on and with the product
- Operation of damaged products
- Wear parts
- Improperly performed repairs
- Unauthorized changes to the operating parameters
- Disasters, external influence, and force majeure

The information in this Operating Manual describes the characteristics of products without assurances. Resellers assume responsibility for the Swedstyle products installed in their applications. They must ensure their product complies with all relevant directives, standards, and laws. Swedstyle shall not be held liable for any damage that is directly or indirectly caused by the delivery or use of this document. Resellers must observe the relevant safety standards and guidelines for each product in the Table System.

2.5 Residual risks

Residual risks are the risks that remain after all relevant safety standards have been complied with. These have been evaluated in the form of a risk assessment. Residual risks associated with the installation of the hand controller are listed here and throughout this Operating Manual.

WARNING. Risk of death or serious injury through electric shocks

Hand controllers are electrical devices. Although you will not have to connect the Handset to the Control Box during assembly, basic safety precautions must be taken at all times. Failure to observe electrical safety precautions may lead to death or serious injury through electric shocks.

- Never open the Handset
- Ensure that the Handset is not connected to the Control Box during assembly
- Do not convert or modify the Handset in any way
- Do not immerse the Handset or its components in liquid. Clean only with a dry or slightly damp cloth
- Do not place the Cable of the Handset on heated surfaces
- Check the housing and cables of the Handset for visible damage. Do not install or operate damaged products.

⚠ WARNING. Risk of death or serious injury in explosive atmospheres

Operating the Handset in potentially explosive atmospheres may lead to death or serious injury through explosions.

- Read the relevant directives to determine if an atmosphere is potentially explosive
- Do not operate the Handset in potentially explosive atmospheres

⚠ CAUTION. Risk of minor or moderate injury through tripping

During the assembly process, you may have to step over Cables. Tripping over Cables may lead to minor or moderate injury.

- Ensure that the assembly area is kept clear of unnecessary obstructions
- Be careful not to trip over Cables

⚠ CAUTION. Risk of minor or moderate injury through crushing

If any Handset Key becomes stuck while the system is in motion, the system may not stop properly. This may lead to minor or moderate injury through crushing.

- Disconnect the system immediately if any Handset Key becomes stuck

3 THE PRODUCT

3.1 Key product features

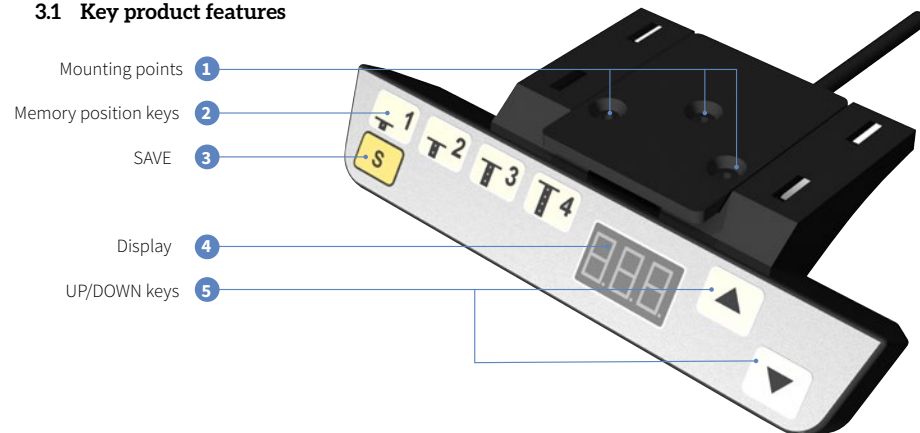

3.2 Dimensions

Length	69 mm
Width	135 mm
Height	25 mm

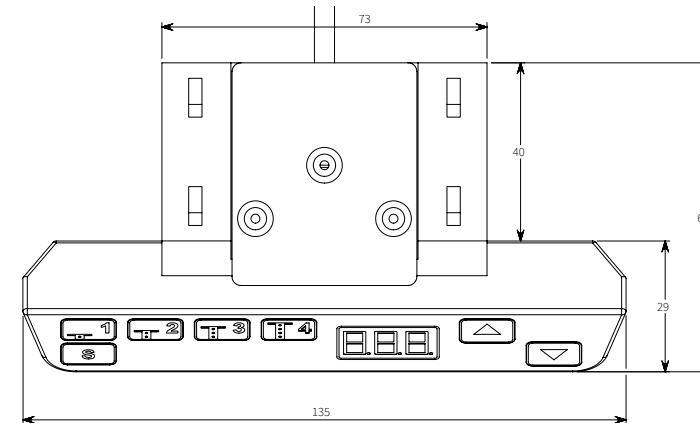
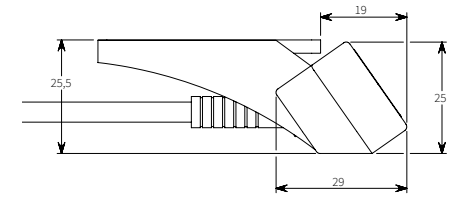

4 ASSEMBLY

⚠ CAUTION. Risk of minor or moderate injury through improper handling

Improper handling of the product during assembly may lead to minor or moderate injury through cutting, pinching, and crushing.

- Avoid contact with sharp edges
- Be careful while handling tools that may cause personal injury
- Ensure assembly complies with the generally accepted standards and guidelines of electrical engineering and furniture manufacturing
- Read all instructions and safety advice carefully

⚠ CAUTION. Risk of minor or moderate injury through tripping

During assembly and operation, poorly routed Cables may become a trip hazard. Tripping over Cables may lead to minor or moderate injury.

- Ensure that Cables are routed properly to avoid trip hazards
- Be careful not to trip over Cables when installing the Handset

! NOTICE

- Ensure proper ESD handling during assembly. Damage that can be attributed to electrostatic discharge will void warranty claims.
- To avoid damage to the product, measure the dimensions of the Handset before assembly.
- Before assembly, all parts must be acclimatised to the ambient conditions.
- Do not lift the Handset by its cable. This will cause irreparable damage to the product.

INFO Perform a product risk assessment so that you can respond to potential residual hazards. Assembly instructions must be included in your end user Operating Manual.

4.1 Required components

The following components are required to assemble the Swedstyle Memory:

Hand controller

3 Mounting screws

Screwdriver

4.2 Process

1. Position the Handset under the table top and mark the position of the Mounting Points.
2. Use the screwdriver and 3 Mounting Screws to attach the Handset to the Table Top at the drilled holes.

NOTICE The required tightening torque depends on the material of the Table Top. Do not exceed 2 Nm.

4.3 Completing assembly

After the Swedstyle Memory is attached to the Table Top, you must connect the Cable to the Control Box.

5 OPERATION**!** CAUTION. Risk of minor or moderate injury through uncontrolled movement

The table may not always stop exactly at the expected position. Failure to anticipate the table's movements may lead to minor or moderate injury through crushing.

- Wait until the system has completely stopped before attempting to use the table

! CAUTION. Risk of minor or moderate injury through unsecured objects

While the table moves up and down, unsecured objects may fall off the table and onto body parts. This may lead to minor or moderate injury through crushing.

- Ensure loose objects are kept away from the edge of the table
- Do not leave unnecessary objects on the table during movement







! CAUTION. Risk of minor or moderate injury through crushing

Failure to release Handset Keys correctly may result in the table failing to stop properly. This may lead to minor or moderate injury through crushing.

- Do not slide your finger to a different Handset key while another button is pressed
- Disconnect the system immediately if any Handset Key becomes stuck

INFO. The technology within the Handset may be interrupted by external interferences during operation. This may lead to certain user inputs (i.e. button presses) not being recognized.

This section of the Operating Manual contains a selection of instructions for operating the Table System to which the Handset is connected. Handset Keys are represented as follows:

	UP Key
	DOWN Key
	SAVE Key
	Memory Position Key 1
	Memory Position Key 2
	Memory Position Key 3
	Memory Position Key 4

5.1 Adjusting the table top height**!** CAUTION. Risk of minor or moderate injury through crushing

Your fingers may be crushed when you attempt to change the height of the table

- Keep fingers away from moving parts
- Ensure that no persons or objects are in the table's range of motion

INFO The Table Top will move up or down until the UP or DOWN Key is released, or if a pre-defined stopping point has been reached.

To move the Table Top UP:







Press and hold  until the desired height has been reached

To move the Table Top DOWN:

Press and hold  until the desired height has been reached

5.2 Saving a memory position

This function saves a set Table Top position. One Memory Position can be saved per Memory Position Key.

1. Move the table to the desired height  
2. The display shows the Table Top height (e.g. 73 cm) 
3. Press the SAVE Key 
4. Press the Memory Position Key (e.g. 2) 
5. The display shows S 2 
6. After about two seconds, the Table Top height is displayed again 

6 ADDITIONAL INFORMATION**6.1 Disassembly**

To disassemble your Handset, ensure that it has been disconnected from the Power Unit. Then, follow the assembly instructions in reverse order.

6.2 Maintenance

The hand controll is maintenance-free for their entire service lifetime.

⚠ WARNING. Risk of death or serious injury through electric shocks and other hazards

Using a Handset alongside unauthorized spare or accessory parts may lead to death or serious injury through electric shocks and other hazards.

- Only use accessory parts produced or approved by Swedstyle
- Only use replacement parts produced or approved by Swedstyle
- Only allow Skilled Persons to perform repairs or install accessory parts
- Contact customer services immediately if the system malfunctions

The use of unauthorized spare or accessory parts may cause system damage. Warranty claims are void in this scenario.

6.3 Cleaning

1. Disconnect the height-adjustable desks power supply from the power source.
2. Wait 30 seconds for residual voltage to dissipate.
3. Wipe the surface of the Handset with a dry soft cloth or a soft cloth lightly moistened in water. Never immerse the Handset into any liquid.
4. Wait for the Handset to dry completely.
5. Reconnect the power supply.

6.4 Replacing a handset

1. Disconnect the Control Box from the Mains.
2. Disconnect the Handset from the Control Box.
3. Remove the Handset from the Table Top.
4. Mount the new Handset onto the Table Top.
5. Plug the Handset back into the Control Box.
6. Reconnect the Control Box to the Mains.

6.5 Troubleshooting

Usually, malfunctions occur when Handsets are pressed while calibrating. If the Handset fails to function, you will need to restart the system. To do this:

1. Unplug the Handset from the Control Box.
2. Plug the Handset back to the motor Control Box.
3. After a few seconds the Handset is ready for operation.

A list of common problems and their solutions can be found in the Operating Manual of the installed Control Box.

6.6 Disposal

The "Swedstyle Memory S" hand controller is subject to the WEEE Directive 2012/19/EU.



Dispose of all components separately from household waste. Use designated collection points or disposal companies authorized for this purpose.

Smart office solutions

Swedstyle AB.

Box 171, SE-567 24 Vaggeryd, Sweden

info@swedstyle.se

+46 393-363 60

www.swedstyle.com

